

**BARBECUE : MASTER 4 SERIES
CLASSIC (MOD. 2017)**

CAMPINGAZ®

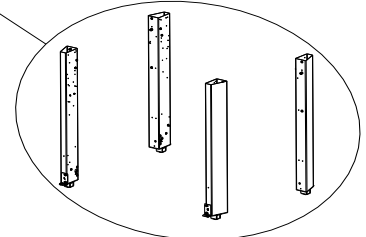

**BARBECUE : MASTER 4 SERIES
CLASSIC (MOD. 2017)**

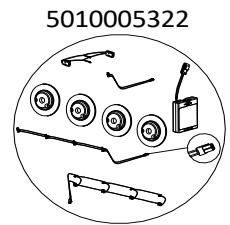

**SCREW BAG
SACHET DE VIS
5010005006**

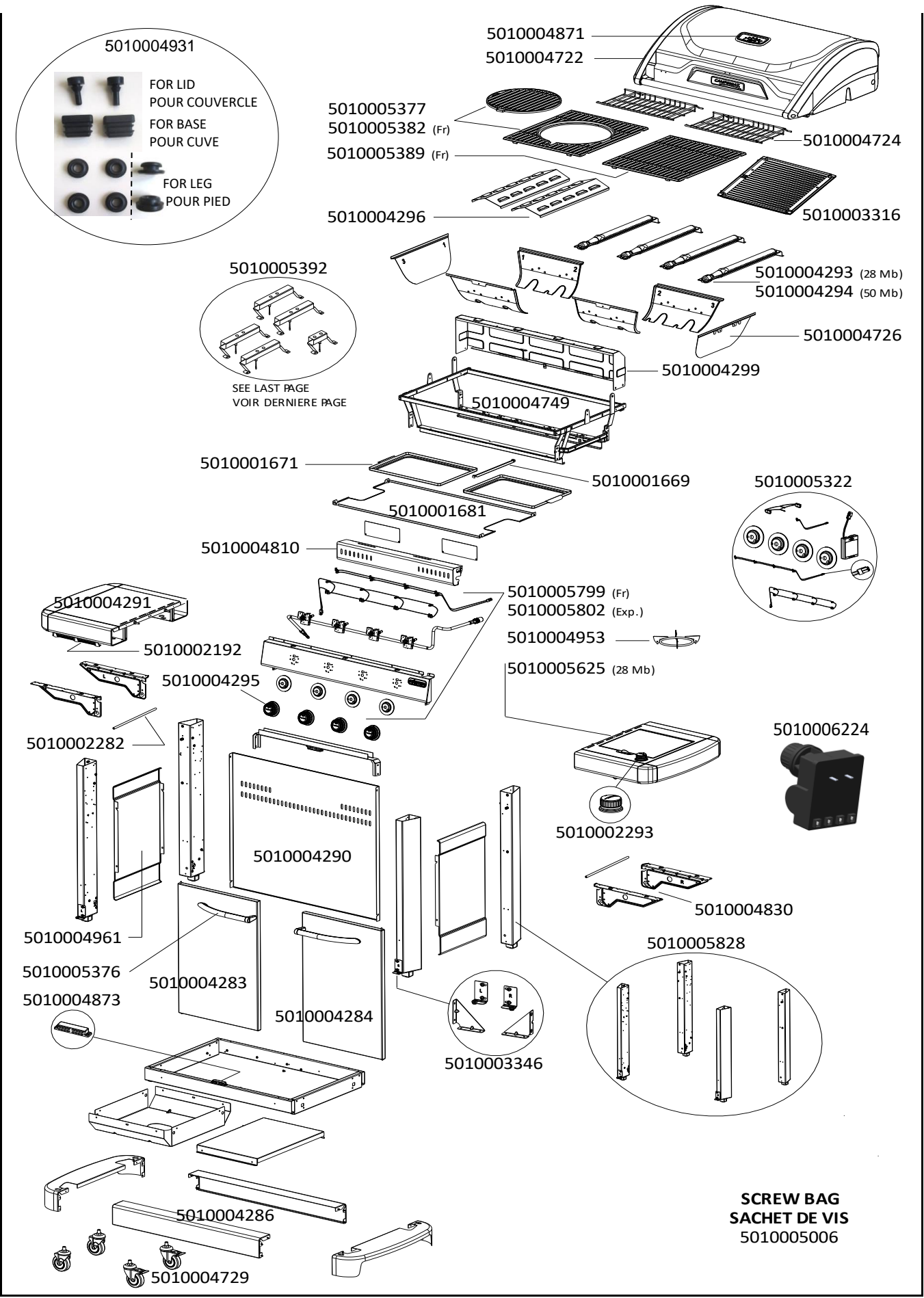

BARBECUE : MASTER 4 SERIES CLASSIC (MOD. 2017)



SPARE PARTS REF.	EN DESCRIPTIONS	FR DESCRIPTIONS
5010001669	GREASE DRAWER TENT	TENTE TIROIR RAMASSE GRAISSE
5010001671	GREASE PLATE (x1)	PLATEAU RAMASSE GRAISSE (x1)
5010001681	HEAT SHIELD	PARE CHALEUR
5010002192	USTENSIL HOOK	PORTE USTENSILES
5010002282	REINFORCEMENT WIRE SIDE SHELF	FIL RENFORT ETAGERE
5010002293	KNOB FOR SIDE STOVE	VOLANT POUR RECHAUD LATERAL
5010003316	REVERSIBLE ENAMELLED CAST IRON COOKING GRIDDLE - MATTE	PLAQUE DE CUISSON FONTE EMAILLEE REVERSIBLE - MATE
5010003346	AXLE SUPPORTS FOR DOORS (MOD. 2016 AND AFTER) + 2 CHASSIS SQUARES	SUPPORTS AXE PORTES (MOD. A PARTIR DE 2016) + 2 EQUERRES CHASSIS
5010004283	LEFT DOOR WITHOUT HANDLE - STAINLESS STEEL	PORTE GAUCHE SANS POIGNEE - INOX
5010004284	RIGHT DOOR WITHOUT HANDLE - STAINLESS STEEL	PORTE DROITE SANS POIGNEE - INOX
5010004286	SKIRT	JUPE
5010004290	REAR PANEL	PANNEAU ARRIERE
5010004291	LEFT SIDE TABLE W/ USTENSIL HOOK	ETAGERE GAUCHE AVEC PORTE USTENSILES
5010004293	STAINLESS STEEL BURNER 28Mb	BRULEUR INOX 28Mb
5010004294	STAINLESS STEEL BURNER 50Mb	BRULEUR INOX 50Mb
5010004295	KNOB (X3)	VOLANT (X3)
5010004296	ENAMELLED STEEL HEAT DIFFUSER (X1)	DIFFUSEUR DE CHALEUR ACIER EMAILLE (X1)
5010004299	WINDSHIELD (BLACK)	PAREVENT (NOIR)
5010004722	STAINLESS STEEL LID WITH THERMOMETER	COUVERCLE INOX AVEC THERMOMETRE
5010004724	WARMING GRID (X2)	GRILLE DE MIJOTAGE (X2)
5010004726	KIT OF REMOVABLE PARTS (FIREBOX)	KIT DE PARTIES AMOVIBLES (CUVE)
5010004729	SET OF WHEELS (x2)	ENSEMBLE ROUES (x2)
5010004749	BASE FRAME (MOD. BEFORE 2018)	CADRE SUPPORT DE CUVE (MOD. AVANT 2018)
5010004810	TOP FRONT PANEL WITH SHIELD (X2)	CONSOLE HAUT AVEC ECRAN THERMIQUE (X2)
5010004830	SIDE SHELF SUPPORTS (RIGHT AND LEFT) - TEXTURED DARK GREY	SUPPORTS ETAGERE (DROITE ET GAUCHE) - TEXTURE GRIS FONCE
5010004871	THERMOMETER WITH NUTS	THERMOMETRE AVEC ECROUS
5010004873	MAGNETS (X2)	AIMANTS (X2)
5010004931	LID PADS (x2) + BASE CUSHIONS (x2) + LEG GROMMETS (x4)	PATINS COUVERCLE (x2) + BOUCHONS CUVE (x2) + RONDELLES PIED (x4)
5010004953	SIDE STOVE PAN SUPPORT	SUPPORT DE CASSEROLE RECHAUD LATERAL
5010004961	LEFT OR RIGHT SIDE PANEL (TEXTURED DARK GREY)	PANNEAU LATERAL GAUCHE OU DROITE (TEXTURE GRIS FONCE)
5010005006	SCREW BAG	SACHET DE VIS
5010005322	ELECTRONIC IGNITION SET	KIT ALLUMAGE ELECTRONIQUE
5010005376	CHROMED STEEL HANDLE (LEFT OR RIGHT) + SCREWS (MOD. 2019 AND AFTER)	POIGNEE ACIER CHROME (GAUCHE OU DROITE) + VIS (MOD. A PARTIR DE 2019)
5010005377	ENAMELLED CAST IRON COOKING GRID (FRAME + CIRCLE) - MATTE (MOD. 2019 AND AFTER)	GRILLE DE CUISSON FONTE EMAILLEE (CADRE + CERCLE) - MATE (MOD. A PARTIR DE 2019)
5010005382	ENAMELLED CAST IRON COOKING GRID (FRAME + CIRCLE) - SHINY (MOD. 2019 AND AFTER)	GRILLE DE CUISSON FONTE EMAILLEE (CADRE+CERCLE) - BRILLANTE (MOD. A PARTIR DE
5010005389	ENAMELLED CAST IRON COOKING GRID - SHINY (MOD. 2019 AND AFTER)	GRILLE DE CUISSON FONTE EMAILLEE - BRILLANTE (MOD. A PARTIR DE 2019)
5010005392	KIT OF ELECTRODES + HOUSINGS	KIT ELECTRODES + SUPPORTS
5010005625	SIDE BURNER TABLE WITH STAINLESS STEEL HOSE 28Mb	ETAGERE RECHAUD LATERAL AVEC TUYAU INOX 28Mb
5010005799	CONTROL PANEL + WIRES (BACKLIGHTING+IGNITION) + STOVE PIPE 28Mb G1/2(Fr)	CONSOLE + CABLAGE (ECLAIRAGE+ALLUMAGE) + TUBULURE RECHAUD 28Mb G1/2 (Fr)
5010005802	CONTROL PANEL + WIRES (BACKLIGHTING+IGNITION) + STOVE PIPE 28Mb (Export)	CONSOLE + CABLAGE (ECLAIRAGE+IGNITION) + TUBULURE RECHAUD 28Mb (Export)
5010005828	KIT LEGS (x4)	KIT PIEDS (x4)
5010006224	ELECTRONIC IGNITOR 4 OUTLETS (FOR MODEL WITH SIDE BURNER)	BOITIER ALLUMAGE ELECTRONIQUE 4 SORTIES (POUR MODELE AVEC RECHAUD LATERAL)

BARBECUE : MASTER 4 SERIES CLASSIC (MOD. 2017)

5010005392

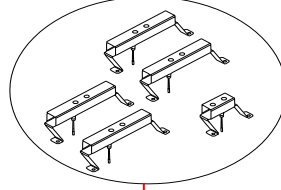

1

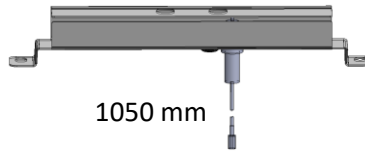

1050 mm

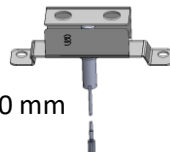

1050 mm

2

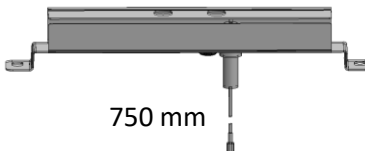

750 mm

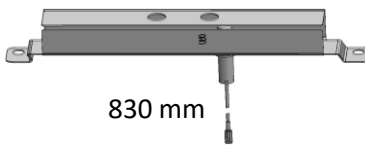

830 mm

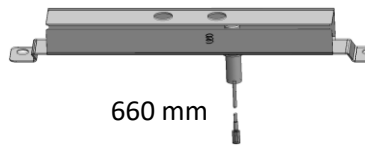

660 mm

