

**BARBECUE : MASTER 4
SERIES WOODY**

CAMPINGGAZ®

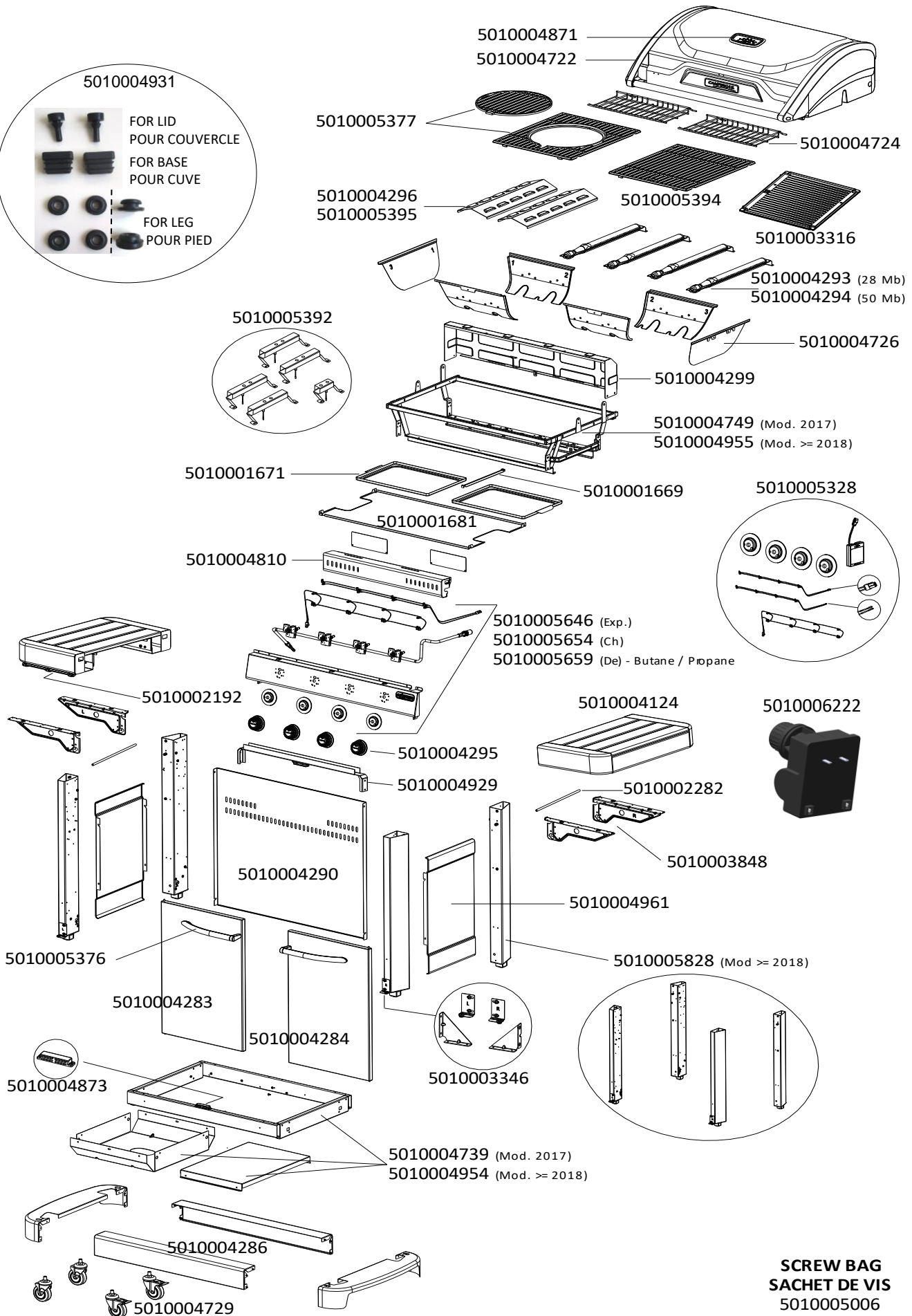

BARBECUE : MASTER 4 SERIES WOODY

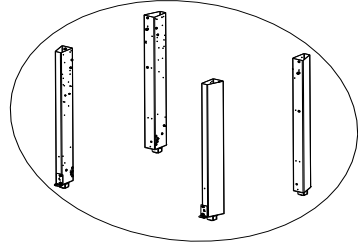
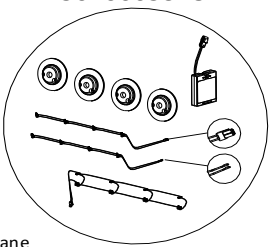
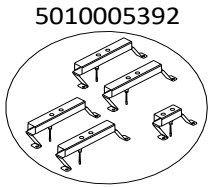

**SCREW BAG
SACHET DE VIS
5010005006**

BARBECUE : MASTER 4 SERIES WOODY

CAMPINGGAZ®

GERÄTE FÜR DEUTSCHLAND UND ÖSTERREICH

WARNING!

Gasgrillgeräte für Deutschland und Österreich können mit zwei verschiedenen Gasleitungen ausgestattet sein:

- Butan und Propan (50 mbar)
- Propan (50 mbar)

Um die für den Grill passende Gasleitung zu finden, schauen Sie bitte auf den am Grill angebrachten Aufkleber, der das



- Logo trägt (hinter der Rückwand angeordnet)

In der mit **DE. AT.** überschriebenen Sektion auf dem Aufkleber (siehe Bilder unten) finden Sie die Version der Gasleitung.

MODELS FOR GERMANY AND AUSTRIA

WARNING!

A barbecue used in Germany and Austria is using one of 2 types of gas pipe:

- Butane and Propane (50 Mbar)
- Propane (50 Mbar)

To find out the type of gas pipe used by a barbecue, see the CE sticker containing the  logo (located behind the rear panel).

In the **DE. AT.** part of the CE label (see pictures below), you will find the type of gas pipe used.

MODELES DESTINES A L'ALLEMAGNE ET L'AUTRICHE

ATTENTION !

Un barbecue destiné à l'Allemagne et l'Autriche utilise un des 2 types de tubulure gaz :

- Butane et propane à 50 mbar
- Propane à 50 mbar

Pour reconnaître le type de tubulure gaz utilisé, consulter l'étiquette CE (placée derrière le panneau arrière) reconnaissable par le logo 

Dans la partie **DE. AT.** de l'étiquette CE (voir les schémas ci-dessous) , le type de tubulure gaz est indiqué.

Gasleitung nur für Propan - Propan gas pipe only - Tubulure gaz n'utilisant que le Propane

FR - ATTENTION: Des parties accessibles peuvent être très chaudes. Eloigner les jeunes enfants. A n'utiliser qu'à l'extérieur des locaux. Consulter la notice avant emploi.	
DE - ACHTUNG :Die zugänglichen Teile am Grill können sehr heiß werden. Halten Sie Kinder davon fern. Nur im Freien benützen. Vor Inbetriebnahme Gebrauchsanweisung lesen.	
IT - ATTENZIONE: Alcune parti esposte possono riscaldarsi. Tenere lontano dalla portata dei bambini. Da utilizzarsi solo all'aria aperta. Leggere le istruzioni per l'uso prima di utilizzare l'apparecchio.	
 1312 - YY 1312 CO 5855	DE. AT. CH: Cat. I_{30P}(50) Propane (G31) 50mbar APPLICATION DES GAZ 219, Route de Brignais - BP 55 ,69563 Saint Genis Laval - France

Gasleitung für Butan und Propan - Butan and Propan gas pipe - Tubulure gaz utilisant le Butane et le Propane

FR - ATTENTION: Des parties accessibles peuvent être très chaudes. Eloigner les jeunes enfants. A n'utiliser qu'à l'extérieur des locaux. Consulter la notice avant emploi.	
DE - ACHTUNG :Die zugänglichen Teile am Grill können sehr heiß werden. Halten Sie Kinder davon fern. Nur im Freien benützen. Vor Inbetriebnahme Gebrauchsanweisung lesen.	
IT - ATTENZIONE: Alcune parti esposte possono riscaldarsi. Tenere lontano dalla portata dei bambini. Da utilizzarsi solo all'aria aperta. Leggere le istruzioni per l'uso prima di utilizzare l'apparecchio.	
 1312 - YY 1312 CO 5855	DE. AT. CH: Cat. I_{30P}(50) Butane (G30) 50 mbar - Propane (G31) 50 mbar APPLICATION DES GAZ 219, Route de Brignais - BP 55 ,69563 Saint Genis Laval - France

BARBECUE : MASTER 4 SERIES WOODY



SPARE PARTS REF.	POINTS	EN DESCRIPTIONS	FR DESCRIPTIONS
5010001669	30	GREASE DRAWER TENT	TENTE TIROIR RAMASSE GRAISSE
5010001671	50	GREASE PLATE (x1)	PLATEAU RAMASSE GRAISSE (x1)
5010001681	60	HEAT SHIELD	PARE CHALEUR
5010002192	40	USTENSIL HOOK	PORTE USTENSILES
5010002282	30	REINFORCEMENT WIRE SIDE SHELF	FIL RENFORT ETAGERE
5010003316	260	REVERSIBLE ENAMELLED CAST IRON COOKING GRIDDLE - MATTE	PLAQUE DE CUISSON FONTE EMAILLEE REVERSIBLE - MATE
5010003346	40	AXLE SUPPORTS FOR DOORS (MOD. 2016 AND AFTER) + 2 CHASSIS SQUARES	SUPPORTS AXE PORTES (MOD. A PARTIR DE 2016) + 2 EQUERRES CHASSIS
5010003848	70	RIGHT AND LEFT SIDE SHELF SUPPORTS	SUPPORTS (DROITE ET GAUCHE) ETAGERE
5010004124	220	LEFT OR RIGHT WOODY SIDE TABLE - TEXTURED DARK GREY	ETAGERE BOIS GAUCHE OU DROITE - GRAINE GRIS FONCE
5010004283	290	LEFT DOOR WITHOUT HANDLE - STAINLESS STEEL	PORTE GAUCHE SANS POIGNEE - INOX
5010004284	290	RIGHT DOOR WITHOUT HANDLE - STAINLESS STEEL	PORTE DROITE SANS POIGNEE - INOX
5010004286	190	SKIRT	JUPE
5010004290	130	REAR PANEL	PANNEAU ARRIERE
5010004293	180	STAINLESS STEEL BURNER 28Mb	BRULEUR INOX 28Mb
5010004294	180	STAINLESS STEEL BURNER 50Mb	BRULEUR INOX 50Mb
5010004295	60	KNOB (X3)	VOLANT (X3)
5010004296	120	ENAMELLED STEEL HEAT DIFFUSER (X1)	DIFFUSEUR DE CHALEUR ACIER EMAILLE (X1)
5010004299	80	WINDSHIELD (BLACK)	PAREVENT (NOIR)
5010004722	980	STAINLESS STEEL LID WITH THERMOMETER	COUVERCLE INOX AVEC THERMOMETRE
5010004724	90	WARMING GRID (X2)	GRILLE DE MIJOTAGE (X2)
5010004726	320	KIT OF REMOVABLE PARTS (FIREBOX)	KIT DE PARTIES AMOVIBLES (CUVE)
5010004729	70	SET OF WHEELS (x2)	ENSEMBLE ROUES (x2)
5010004739	250	CHASSIS (MOD. 2017)	CHASSIS (MOD. 2017)
5010004749	180	BASE FRAME (MOD. BEFORE 2018)	CADRE SUPPORT DE CUVE (MOD. AVANT 2018)
5010004810	60	TOP FRONT PANEL WITH SHIELD (X2)	CONSOLE HAUT AVEC ECRAN THERMIQUE (X2)
5010004871	90	THERMOMETER WITH NUTS	THERMOMETRE AVEC ECROUS
5010004873	50	MAGNETS (X2)	AIMANTS (X2)
5010004929	50	TROLLEY TOP REINFORCEMENT BAR	BARRE SUPERIEURE DE RENFORT CHARIOT
5010004931	50	LID PADS(x2) + BASE CUSHIONS(x2) + LEG GROMMETS(x4)	PATINS COUVERCLE(x2) + BOUCHONS CUVE(x2) + RONDELLES PIED(x4)
5010004950	210	LEFT SIDE PANEL W/ LEGS (MOD. 2018-2019)	PANNEAU GAUCHE AVEC PIEDS (MOD. 2018-2019)
5010004951	210	RIGHT SIDE PANEL W/ LEGS (MOD. 2018-2019)	PANNEAU DROITE AVEC PIEDS (MOD. 2018-2019)
5010004954	250	CHASSIS (MOD. 2018 AND AFTER)	CHASSIS (MOD. A PARTIR DE 2018)
5010004955	210	BASE FRAME (MOD. 2018 AND AFTER)	CADRE SUPPORT DE CUVE (MOD. A PARTIR DE 2018)
5010004961	70	LEFT OR RIGHT SIDE PANEL (TEXTURED DARK GREY)	PANNEAU LATERAL GAUCHE OU DROITE (GRAINE GRIS FONCE)
5010005006	80	SCREW BAG	SACHET DE VIS
5010005328	250	ELECTRONIC IGNITION SET	KIT ALLUMAGE ELECTRONIQUE
5010005376	120	CHROMED STEEL HANDLE (LEFT OR RIGHT) + SCREWS (MOD. 2019 AND AFTER)	POIGNEE ACIER CHROME (GAUCHE OU DROITE) + VIS (MOD. A PARTIR DE 2019)
5010005377	270	ENAMELLED CAST IRON COOKING GRID (FRAME + CIRCLE) - MATTE (MOD. 2019 AND AFTER)	GRILLE DE CUISSON FONTE EMAILLEE (CADRE + CERCLE) - MATE (MOD. A PARTIR DE 2019)
5010005392	180	KIT OF ELECTRODES + HOUSINGS	KIT ELECTRODES + SUPPORTS
5010005394	210	ENAMELLED CAST IRON COOKING GRID - MATTE (MOD. 2019 AND AFTER)	GRILLE DE CUISSON FONTE EMAILLEE - MATE (MOD. A PARTIR DE 2019)
5010005395	130	STAINLESS STEEL HEAT DIFFUSOR (X1)	DIFFUSEUR DE CHALEUR INOX (X1)
5010005646	690	CONTROL PANEL + WIRES (BACKLIGHTING + IGNITION) + PIPE 28Mb (Export)	CONSOLE + CABLAGE (ECLAIRAGE + ALLUMAGE) + TUBULURE 28Mb (Export)

BARBECUE : MASTER 4 SERIES WOODY

SPARE PARTS REF.	POINTS	EN DESCRIPTIONS	FR DESCRIPTIONS
5010005654	700	CONTROL PANEL + WIRES (BACKLIGHTING + IGNITION) + PIPE 28Mb 1/4"(Ch)	CONSOLE + CABLAGE (ECLAIRAGE + ALLUMAGE) + TUBULURE 28Mb 1/2"(Ch)
5010005659	800	CONTROL PANEL + WIRES (BACKLIGHTING + IGNITION) + PIPE 50Mb 1/2" (De) - BUTANE AND PROPANE MODELS	CONSOLE + CABLAGE (ECLAIRAGE + ALLUMAGE) + TUBULURE 50Mb (De) - MODELES BUTANE ET PROPANE
5010005828	450	KIT LEGS (x4)	KIT PIEDS (x4)
5010006222	90	ELECTRONIC IGNITOR 2 OUTLETS (FOR BARBECUE WITHOUT SIDE BURNER)	BOITIER ALLUMAGE ELECTRONIQUE 2 SORTIES (POUR BARBECUE SANS RECHAUD LATERAL)

